

5.66m² growing area Planter Type A

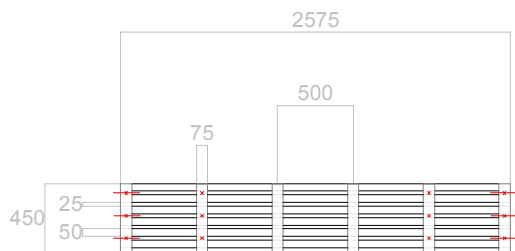

① Piece 1, x4

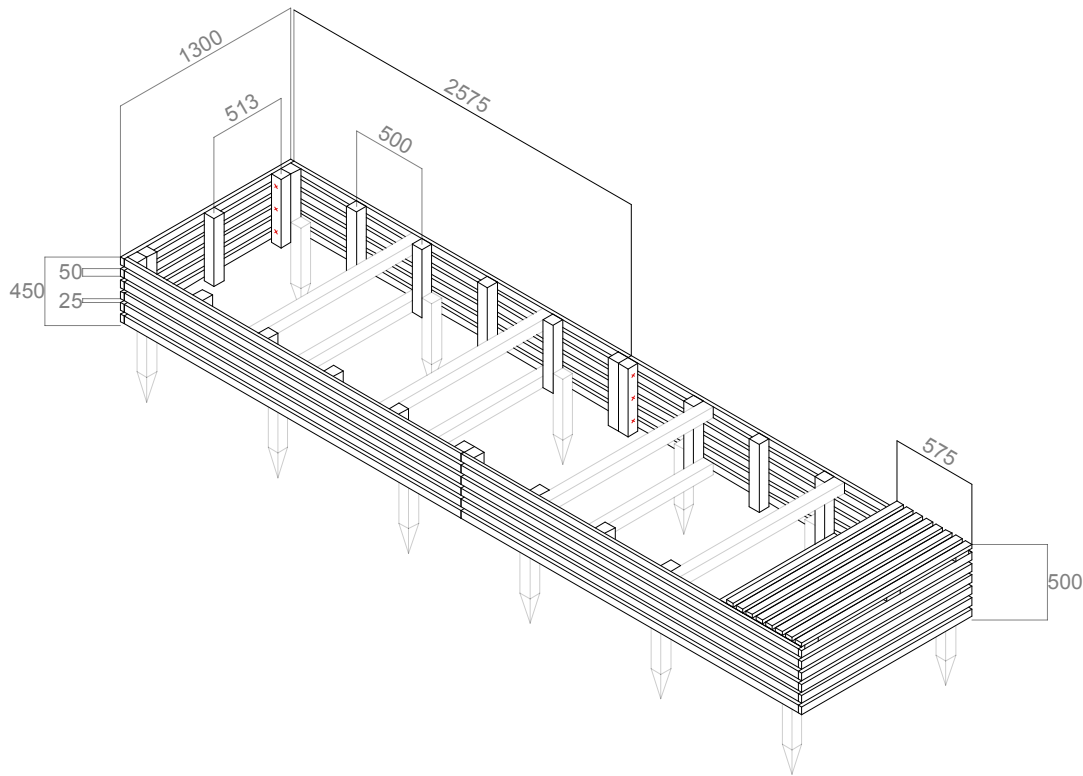
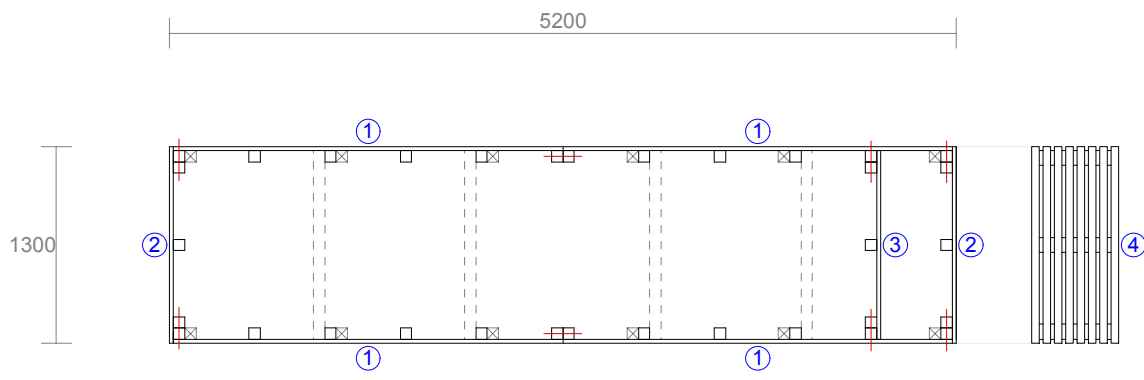
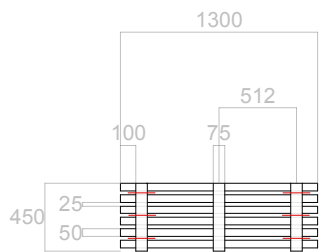

② Piece 2, x2

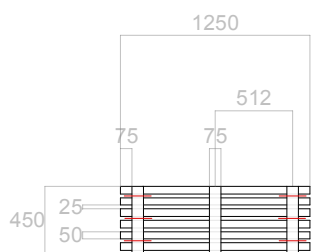

③ Piece 3, x1

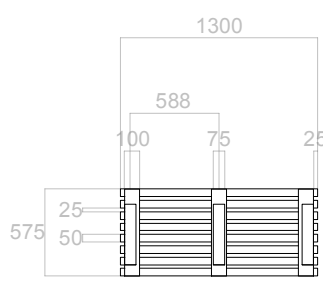

Lid From Below

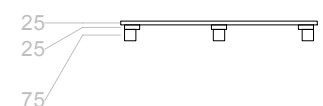

Lid Section

④ Piece 4 (seat lid), x1
Lid to interlock with structure below

Notes:
Area under seat to be used as storage.
Battons set out at 500mm centres

— = Direction of pre-drilled holes
• = Position of pre-drilled hole

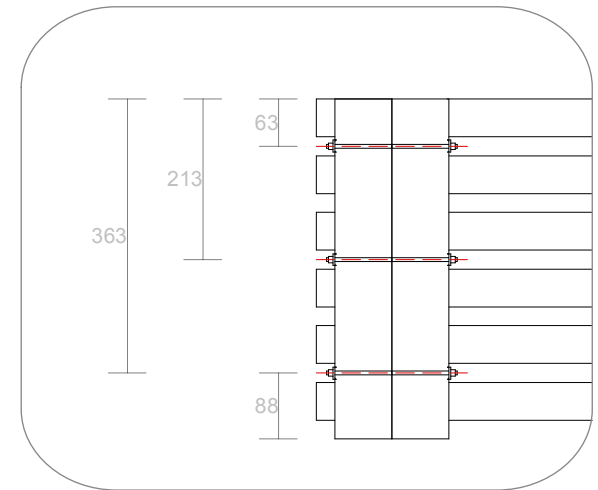

1:10 detail elevation to show position of drilled holes between slats

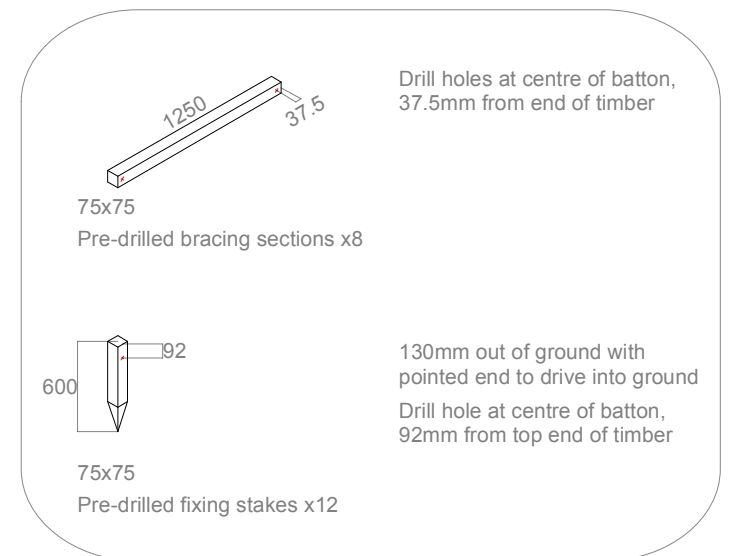

Additional timbers for fixing Pieces together and to the ground

VACANT LOT PARTNERSHIP Planter Dimensions



Dwg Title: Vacant Lot Planter Type A - Dimensions
Dwg No.: VL-PlanterA-01
Revision:
Scale: 1:50 unless indicated otherwise
Date created: 26.03.10

Rev.

WHAT IF: projects Ltd

39 Cropley Street, London N1 7HT
T. 02072533376
www.what-if.info